



---



---



---



---



---



---

2-Cinghie elastiche. 4-Poliuretano espanso in densità e spessori diversi. 8-Riempimento di piume, stabilizzate a settori. 13-Telaio tubolare metallico. 24-Fibra di poliestere accoppiata a tessuto di cotone. 45-Gambe in metallo.

2-Elastic straps. 4-Expanded polyurethane in different thickness and densities. 8-Padding with feathers, stabilised in sectors. 13-Tubular metallic frame. 24-Polyester fibre joined with cotton fabric. 45-Metallic feet.

2-Sangles élastiques. 4-Polyuréthane expansé en différent épaisseurs et densités. 8-Garnis de duvet piquagées en secteurs. 13-Châssis métallique tubulaire. 24-Fibre de polyester avec tissu de coton. 45-Pieds en métal.

2-Elastische Gurtel. 4-Polyuretanschaum in verschiedenen Stärken und Dichten. 8-In Kammern unterteilte Daunenfüllung. 13-Metallrohrrahmen. 24-Polyesterfaser mit Baumwollauflage. 45-Metallfüße.

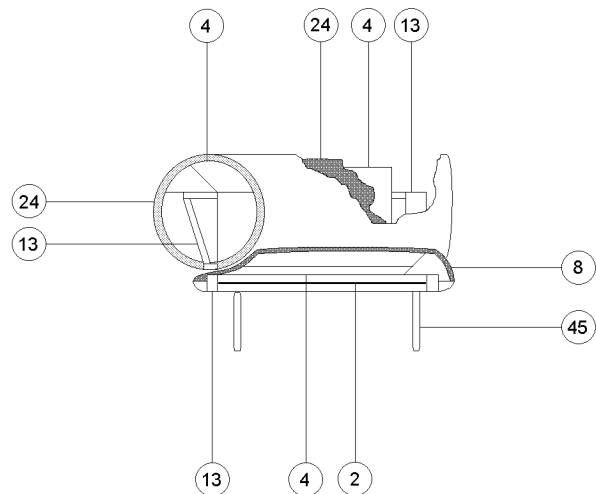

\* Opzione Standard; sarà montato qualora non vi siano richieste specifiche nell'ordine  
 Standard Option; will be assembled as far as no specific requests are mentioned in the order.  
 Option Standard; il sera monté, si n'y a pas demandes spécifiques sur la commande.  
 Standard Option; wird montiert, wenn auf dem Auftrag keine spezifischen Ausführung angegeben ist.

L=Lunghezza,P=Profondità,H=Altezza,Hs=Altezza Seduta,Ps=Profondità Seduta,HBr=Altezza Bracciolo,LBr=Larghezza Bracciolo  
 L=Lenght,P=Deep,H=Height,Hs=Seat Height,Ps=Seat deep,HBr=Armrest Height,LBr=Armrest Breadth  
 L=Longeur,P=Profondeur,H=Hauteur,Hs=Hauteur d'assise,Ps=Profondeur d'assise,HBr=Hauteur d'accoudoir,LBr=Largheur d'accoudoir  
 L=Länge,P=Tiefe,H=Höhe,Hs=Sitzhöhe,Ps=Sitztiefe,HBr=Armlehnhöhe,LBr=Armlehnbreite

Tutti i prezzi sono in Euro All Price are in Euro Toutes les prix sont en Euro Alle Preise sind in Euro

# RONDO

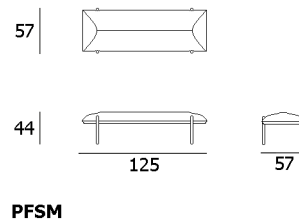
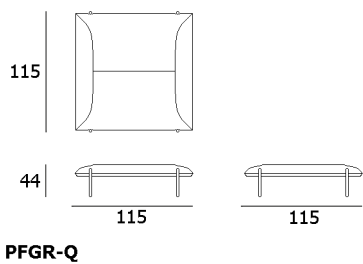
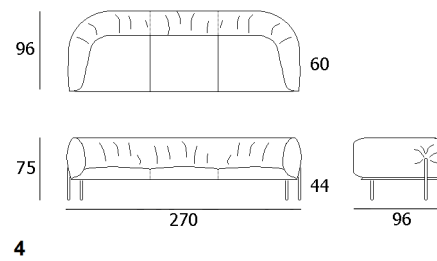
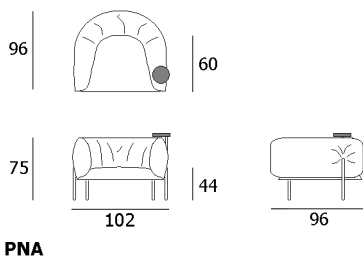
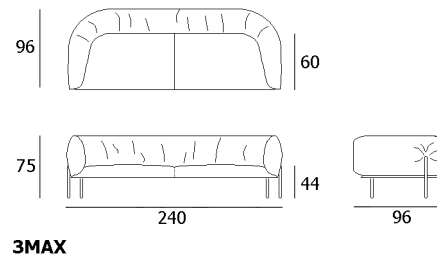
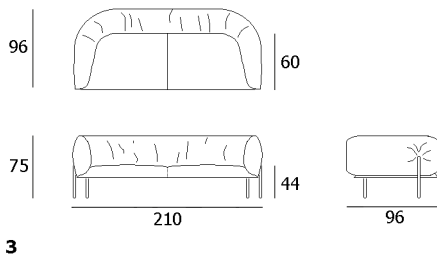
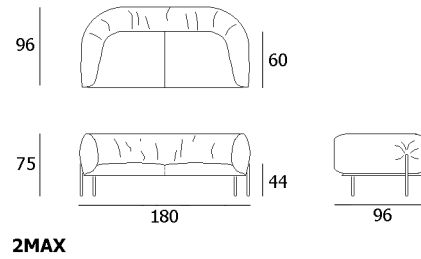
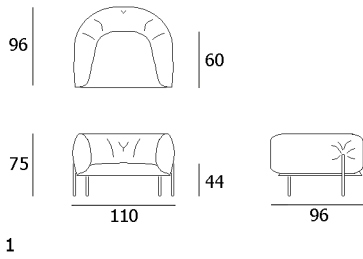

# RONDO

---

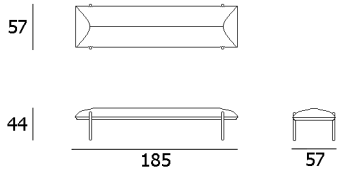

**PFGR**

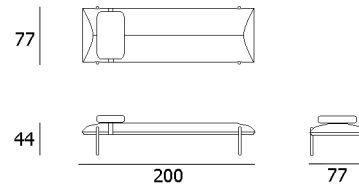

**D-BED**

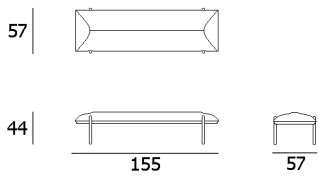

**PFMD**

---