

OPZIONI-OPTIONS-OPTIONEN



BAL* BASAMENTO CROMATO FUßGESTELL VERCHROMT
CHROMIUM PLATED BOARD SOCLE CHROMÉ

SFOD+5% RIVESTIMENTO SFODERABILE +5% ABZIEHBARER BEZUG +5%
REMOVABLE SLIP COVER +5% REVETEMENT DÉDOUBLABLE +5%

PLISSE' Finitura plisse' Bezug Plissee' Cover plisse' Revêtement plisse'

1-Solida struttura in legno. 4-Poliuretano espanso in densità e spessori diversi. 8-Riempimento di piume, stabilizzate a settori. 9-Poliuretano espanso pregiato. 19-Fibra acrilica. 26-Doghe in faggio sagomato. 31-Gambe in metallo cromato.

1-Sturdy inner wooden frame. 4-Expanded polyurethane in different thickness and densities. 8-Padding with feathers, stabilised in sectors. 9-High-grade expanded polyurethane. 19-Acrylic fibre. 26-Slats made of moulded beech plywood. 31-Chromed metallic feet.

1-Structure in bois solide. 4-Polyuréthane expansé en différent épaisseurs et densités. 8-Garnis de duvet piquagées en secteurs. 9-Polyuréthane expansé haute qualité. 19-Fibre acrylique. 26-Lattes souples de hêtre. 31-Pieds en metall chromée.

1-Stabiles Holzgestell. 4-Polyuretanschaum in verschiedenen Stärken und Dichten. 8-In Kammern unterteilte Daunenfüllung. 9-Hochwertiger Polyuretanschaum. 19-Acrylfaser. 26-Lattenrost aus Buche-Formsperrholz. 31-Verchromte Metallfüße.

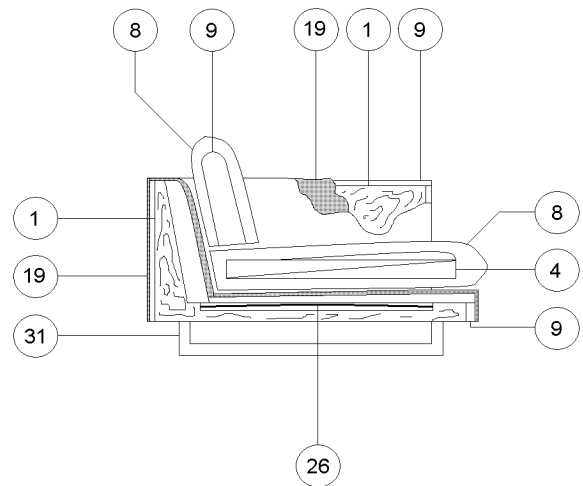

* Opzione Standard; sarà montato qualora non vi siano richieste specifiche nell'ordine
Standard Option; will be assembled as far as no specific requests are mentioned in the order.
Option Standard; il sera monté, si n'y a pas demandes spécifiques sur la commande.
Standard Option; wird montiert, wenn auf dem Auftrag keine spezifischen Ausführung angegeben ist.

L=Lunghezza,P=Profondità,H=Altezza,Hs=Altezza Seduta,Ps=Profondità Seduta,HBr=Altezza Bracciolo,LBr=Larghezza Bracciolo

L=Lenght,P=Deep,H=Height,Hs=Seat Height,Ps=Seat deep,HBr=Armrest Height,LBr=Armrest Breadth

L=Longueur,P=Profondeur,H=Hauteur,Hs=Hauteur d'assise,Ps=Profondeur d'assise,HBr=Hauteur d'accoudoir,LBr=Largueur d'accoudoir

L=Länge,P=Tiefe,H=Höhe,Hs=Sitzhöhe,Ps=Sitztiefe,HBr=Armlehnhöhe,LBr=Armlehnbreite

Tutti i prezzi sono in Euro All Price are in Euro Toutes les prix sont en Euro Alle Preise sind in Euro

PLEASURE

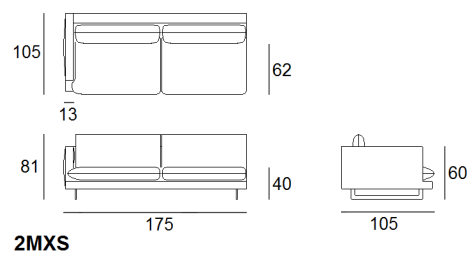
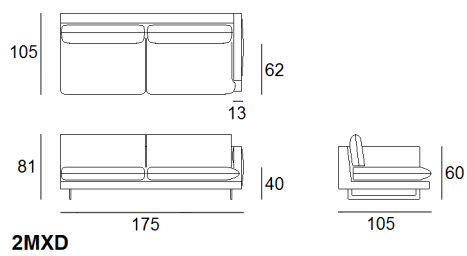
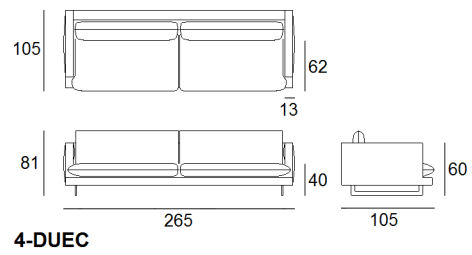
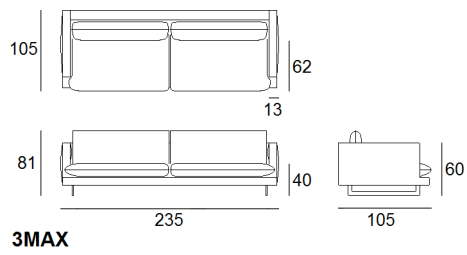
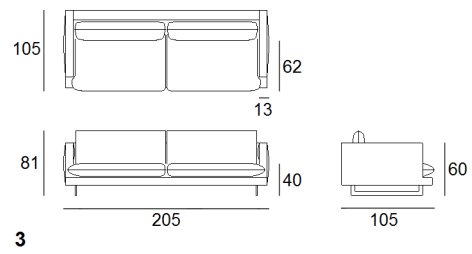
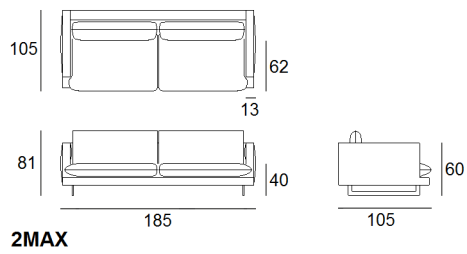
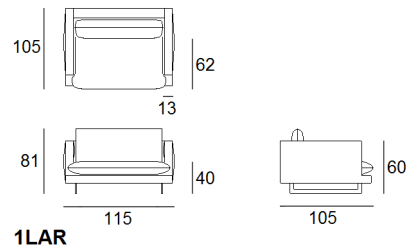
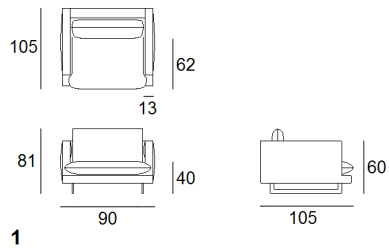

PLEASURE

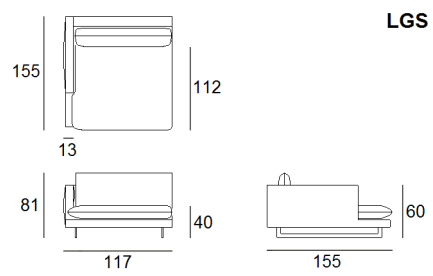
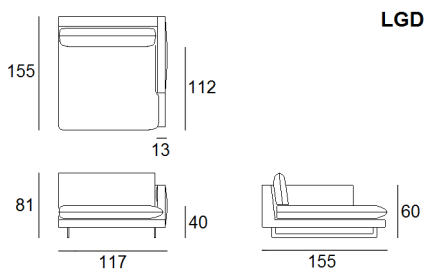
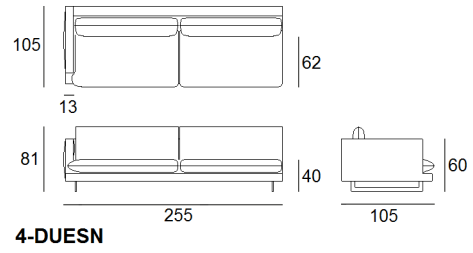
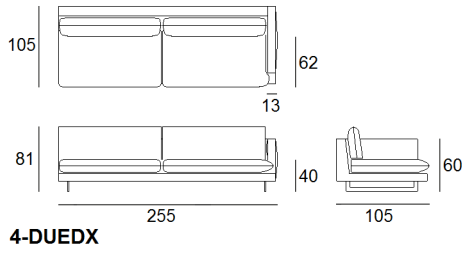
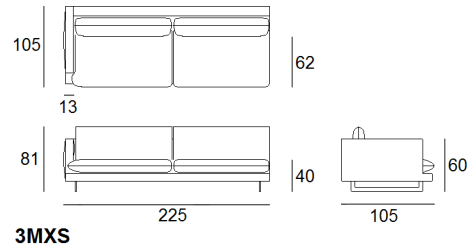
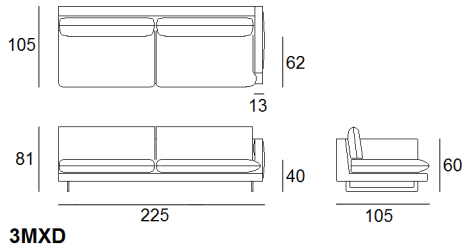
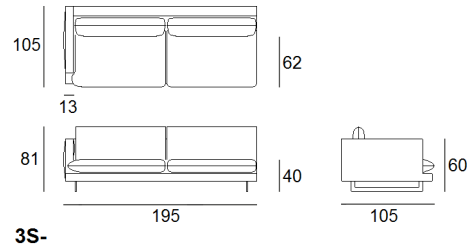
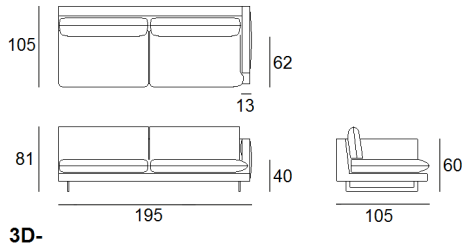

PLEASURE

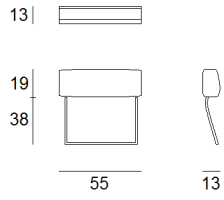

AT