

OPZIONI-OPTIONS-OPTIONEN



PAL090*	PIEDE METALLICO BRONZATO FÜSSE AUS BRUNIERTEM METALL FEET IN BRONZED METALL PIEDS EN METAL BRONZE
SFOD+5%	RIVESTIMENTO SFODERABILE +5% ABZIEHBARER BEZUG +5% REMOVABLE SLIP COVER +5% REVETEMENT DÉDOUBLABLE +5%

1-Solida struttura in legno. 3-Poliuretano espanso.  
 4-Poliuretano espanso in densità e spessori diversi.  
 8-Riempimento di piume, stabilizzate a settori.  
 9-Poliuretano espanso pregiato. 24-Fibra di poliestere accoppiata a tessuto di cotone. 30-Telaio tubolare metallico con cinghie elastiche. 42-Visco foam. 45-Gambe in metallo.

1-Sturdy inner wooden frame. 3-Expanded polyurethane.  
 4-Expanded polyurethane in different thickness and densities. 8-Padding with feathers, stabilised in sectors.  
 9-High-grade expanded polyurethane. 24-Polyester fibre joined with cotton fabric. 30-Tubular metallic frame with elastic straps. 42-Visco foam. 45-Metallic feet.

1-Structure in bois solide. 3-Polyuréthane expansé.  
 4-Polyuréthane expansé en différent épaisseurs et densités. 8-Garnis de duvet piquagées en secteurs.  
 9-Polyuréthane expansé haute qualité. 24-Fibre de polyester avec tissu de coton. 30-Châssis métallique tubulaire avec sangles élastiques. 42-Visco foam. 45-Pieds en métal.

1-Stabiles Holzgestell. 3-Polyuretanschaum.  
 4-Polyuretanschaum in verschiedenen Stärken und Dichten. 8-In Kammern unterteilte Daunenfüllung.  
 9-Hochwertiger Polyuretanschaum. 24-Polyesterfaser mit Baumwollauflage. 30-Metallrohrrahmen mit elastischen Gurten. 42-Visco foam. 45-Metallfüße.

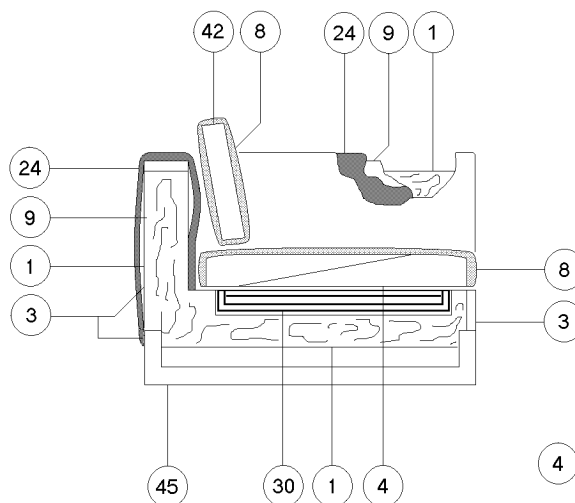

\* Opzione Standard; sarà montato qualora non vi siano richieste specifiche nell'ordine  
 Standard Option; will be assembled as far as no specific requests are mentioned in the order.  
 Option Standard; il sera monté, si n'y a pas demandes spécifiques sur la commande.  
 Standard Option; wird montiert, wenn auf dem Auftrag keine spezifischen Ausführung angegeben ist.

L=Lunghezza,P=Profondità,H=Altezza,Hs=Altezza Seduta,Ps=Profondità Seduta,HBr=Altezza Bracciolo,LBr=Larghezza Bracciolo  
 L=Lenght,P=Deep,H=Height,Hs=Seat Height,Ps=Seat deep,HBr=Armrest Height,LBr=Armrest Breadth  
 L=Longueur,P=Profondeur,H=Hauteur,Hs=Hauteur d'assise,Ps=Profondeur d'assise,HBr=Hauteur d'accoudoir,LBr=Largueur d'accoudoir  
 L=Länge,P=Tiefe,H=Höhe,Hs=Sitzhöhe,Ps=Sitztiefe,HBr=Armlehnhöhe,LBr=Armlehnbreite

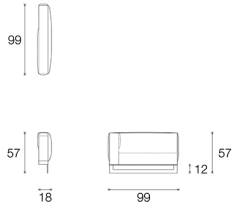

BRDX-A

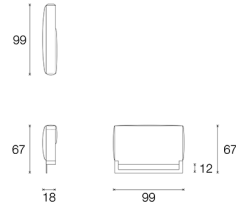

BRSN-A

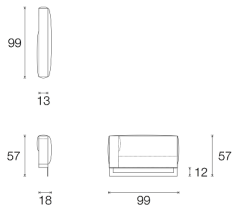

BRDX-B

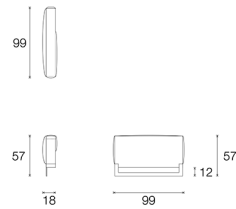

BRSN-B

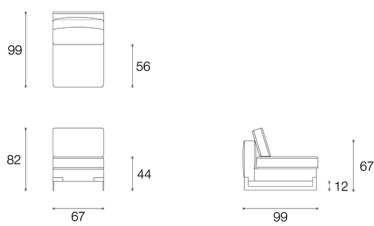

ELP

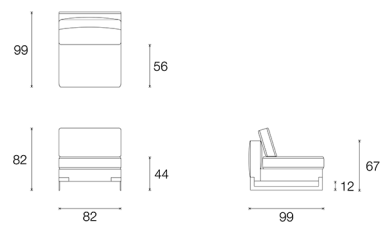

E080

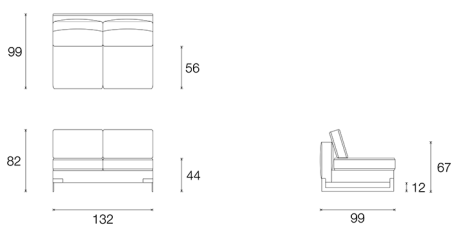

E130

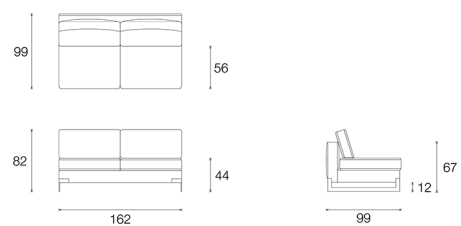

E160

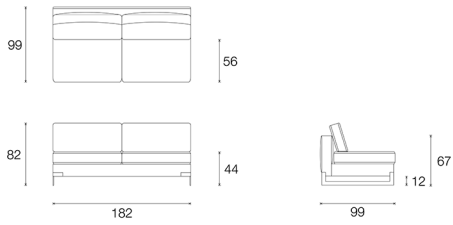

E180

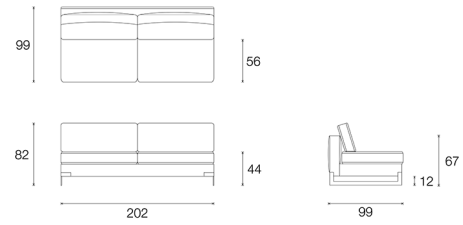

E200

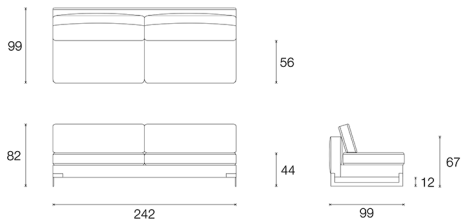

E240

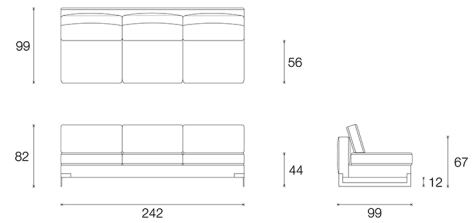

E240-3

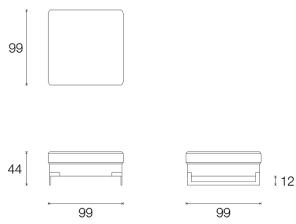

PF100

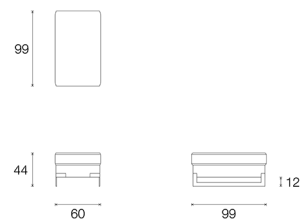

PFGR

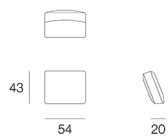

CUSBR